

JUWEL[®]
AQUARIUM

AQUARIEN & ZUBEHÖR

2022/2023



JUWEL AQUARIUM

Aquarien höchster Qualität aus Deutschland



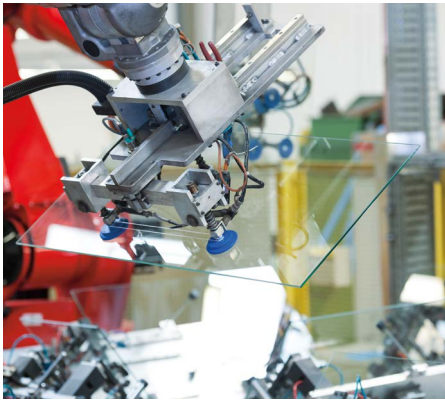

Präzision und modernste Fertigungstechnik
in allen Produktionsschritten

Seit über 50 Jahren steht JUWEL Aquarium für Qualität und Innovationen im Aquarienbau und setzt dabei Maßstäbe in Design und Technologie. Von Beginn an stand dabei der Systemgedanke im Vordergrund.

Schon früh entwickelten wir auch die benötigte Technik für den erfolgreichen Betrieb eines Aquariums und konnten so als erste Marke ein Aquariensortiment anbieten, bei welchem alle Komponenten perfekt aufeinander abgestimmt sind.

Diesem Prinzip sind wir treu geblieben und so steht JUWEL Aquarium heute für hochwertige Systemaquarien, modernste Produktionstechnologie und höchste Qualitätsstandards.

Bis heute arbeitet ein erfahrenes Team stetig und mit großer Einsatzfreude daran, Ihren Fischen ein schönes Zuhause zu schaffen. Diese Leistung hat uns zur Marke des Jahrhunderts und gleichzeitig zur Aquarienmarke Nummer 1 in Europa gemacht.



**NEW
COLOUR**



Lido 120 LED

NEW COLOUR

Zeitlos und elegant. Bekannte Aquarienmodelle im neuen Dekor.

ab Winter 2022



Lido 200 LED

Lido 120 LED

Rio 240 LED



Rio 125 LED



Rio 180 LED



Rio 180 LED



RIO 125

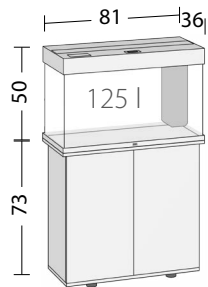

BELEUCHTUNG

LED 590 mm

FILTERLEISTUNG

500 l/h, 5,5 Watt

REGELHEIZER

100 Watt

RIO 180

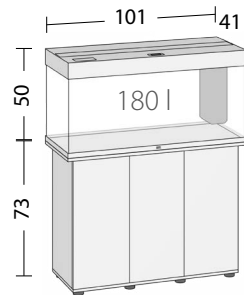

BELEUCHTUNG

LED 895 mm

FILTERLEISTUNG

600 l/h, 7 Watt

REGELHEIZER

200 Watt

RIO 240

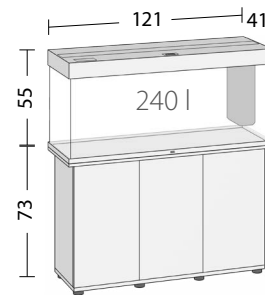

BELEUCHTUNG

LED 1047 mm

FILTERLEISTUNG

600 l/h, 7 Watt

REGELHEIZER

200 Watt

DEKORE



Schwarz



Grau



Weiss



Helles
Holz



Dunkles
Holz

QUALITY
made in
Germany



Rio 450 LED

RIO 350

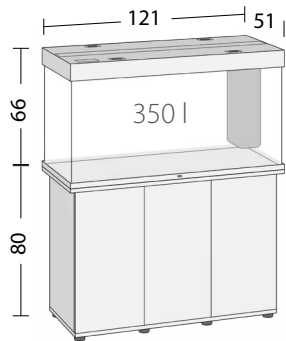

BELEUCHTUNG

LED 1047 mm

FILTERLEISTUNG

1000 l/h, 8 Watt

REGELHEIZER

300 Watt

RIO 450

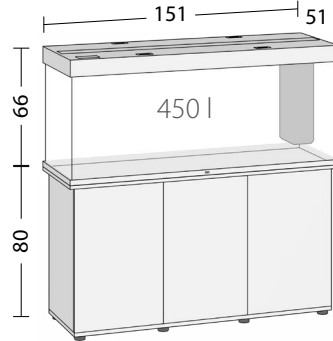

BELEUCHTUNG

LED 1200 mm

FILTERLEISTUNG

1000 l/h, 8 Watt

REGELHEIZER

300 Watt

Rio 350 LED



DEKORE



Schwarz



Weiss



Helles
Holz



Dunkles
Holz

QUALITY
made in
Germany



Lido 120 LED

LIDO 120

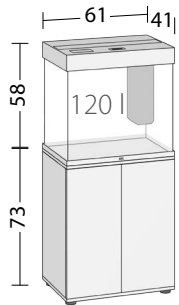

BELEUCHTUNG

LED 438 mm

FILTERLEISTUNG

500 l/h, 5,5 Watt

REGELHEIZER

100 Watt

LIDO 200

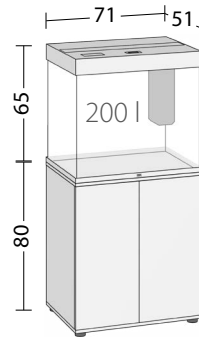

BELEUCHTUNG

LED 590 mm

FILTERLEISTUNG

600 l/h, 7 Watt

REGELHEIZER

200 Watt

Lido 200 LED



DEKORE



Schwarz



Grau



Weiss



Helles
Holz

QUALITY
made in
Germany



Vision 180 LED

VISION 180

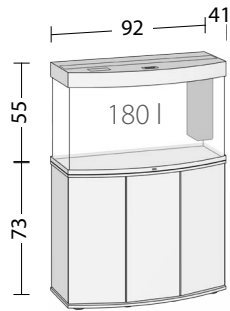

BELEUCHTUNG

LED 742 mm

FILTERLEISTUNG

600 l/h, 7 Watt

REGELHEIZER

200 Watt

VISION 260

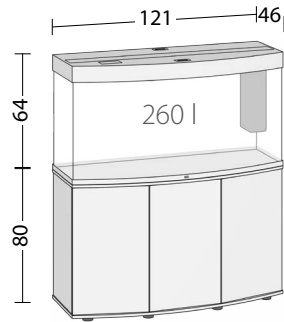

BELEUCHTUNG

LED 1047 mm

FILTERLEISTUNG

1000 l/h, 8 Watt

REGELHEIZER

300 Watt

VISION 450

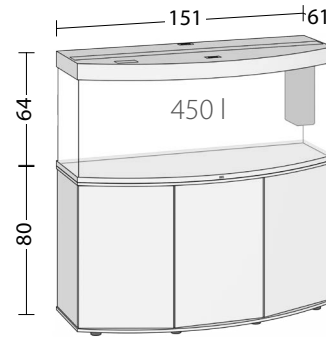

BELEUCHTUNG

LED 1200 mm

FILTERLEISTUNG

1000 l/h, 8 Watt

REGELHEIZER

300 Watt

DEKORE



Schwarz



Weiss



Helles
Holz

QUALITY
made in
Germany



Trigon 190 LED

TRIGON 190

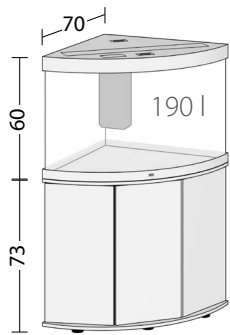

BELEUCHTUNG

LED 590 mm

FILTERLEISTUNG

600 l/h, 7 Watt

REGELHEIZER

200 Watt

TRIGON 350

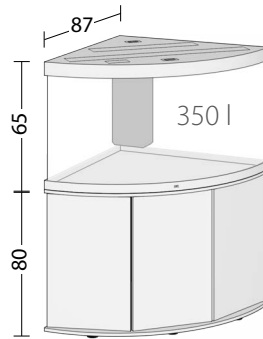

BELEUCHTUNG

LED 438 mm + 895 mm

FILTERLEISTUNG

1000 l/h, 8 Watt

REGELHEIZER

300 Watt

Trigon 190 LED

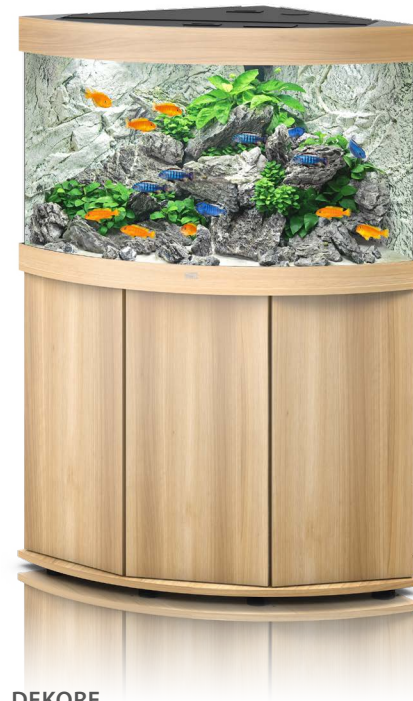

DEKORE



Schwarz



Weiss



Helles
Holz

QUALITY
made in
Germany



Primo 110 LED

PRIMO 70



BELEUCHTUNG

NovoLux LED 60, 8 Watt

FILTERLEISTUNG

300 l/h, 4,4 Watt

REGELHEIZER

50 Watt

PRIMO 110



BELEUCHTUNG

NovoLux LED 80, 10,5 Watt

FILTERLEISTUNG

500 l/h, 5,5 Watt

REGELHEIZER

100 Watt

ALL INCLUSIVE

BELEUCHTUNG

NovoLux LED

Durch Click System erweiterbar



FILTER SYSTEM

Bioflow Filter

Leistungsstarker Bio-Innenfilter



HEIZER

AquaHeat

Stufenlos regelbarer Premium-Heizer unsichtbar im Filtersystem integriert



DEKORE



Schwarz



Weiss

QUALITY

made in
Germany

DAS HERZ EINES JUWEL AQUARIUMS

Das Bioflow Filter System

EccoFlow



Umwälzpumpe

Hocheffiziente und flüsterleise Strömungspumpe der neuen EccoFlow - Generation mit doppelgelagerter Impellerachse.

AquaHeat

Premium Regelheizer

Unsichtbar im Wasserkreislauf integrierter Regelheizer.

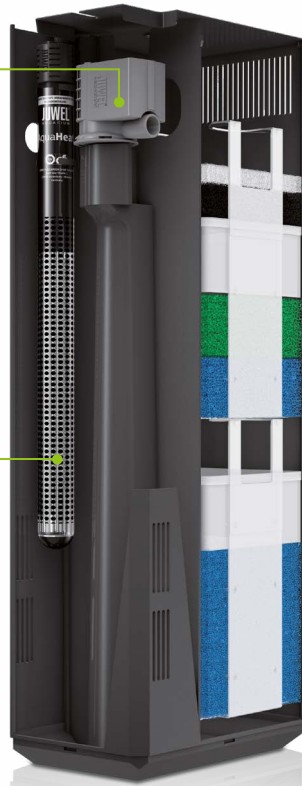

1. Filter-Phase



Hohe Strömungsgeschwindigkeit

Im oberen Bereich des Filtersystems gewährleistet die erhöhte Strömungsgeschwindigkeit eine ideale mechanische und chemische Filterung Ihres Aquariums.

2. Filter-Phase



Geringe Strömungsgeschwindigkeit

Die reduzierte Strömungsgeschwindigkeit im unteren Bereich des Filtersystems begünstigt die Entfaltung von Bakterien im anaeroben Bereich, welche für die biologische Filterung eines Aquariums von essentieller Bedeutung sind.

Vorteile

Millionenfach bewährtes Innenfiltersystem



Einfache Handhabung

Besonders einfache Pflege und Wartung dank praktischer Filterkörbe.



Filtervolumen

Großes Filtervolumen für besonders hohe Filterleistung und lange Standzeiten.



2-Phasen Reinigung

Hervorragende Filterung dank Doppelstromprinzip für eine optimale Entfaltung von Filterbakterien.



Höchste Sicherheit

Keine nach außen führenden Schlauchverbindungen. Das Wasser bleibt im Aquarium.

Vielfältige Filtermedien inklusive

Perfekt aufeinander abgestimmte Filtermedien gewährleisten eine optimale Filterung.



bioPad
Filterwatte

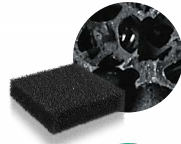

bioCarb
Aktivkohleschwamm



Nitrox
Nitratentferner



bioPlus coarse
Grobporiger Filterschwamm

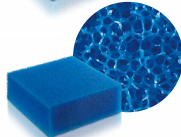

bioPlus fine
Feinporiger Filterschwamm

OPTIONAL



Amorax
Ammoniumentferner



Carbox
Hochwirksame Aktivkohle



Cirax
Keramikgranulat



Phorax
Phosphatentferner

Der neue Standard

MultiLux LED

Aquarien mit modernster LED-Beleuchtung



Wechselbare
LED Röhren



Optimales
Lichtspektrum für
Pflanzen und Fische



Energieersparnis



Inklusive
Leuchtmedien



LED DAY – 9000 K

Hochleistungs-LED-Röhre mit
hellem, belebendem Licht für Ihre
MultiLux LED Einsatzleuchte.



LED NATURE – 6500 K

Hochleistungs-LED-Röhre mit
warmem, natürlichem Licht für Ihre
MultiLux LED Einsatzleuchte.





OPTIONAL



LED COLOUR – 4425 K

Hochleistungs-LED-Röhre mit warmem, rötlichem Licht für Ihre MultiLux LED Einsatzleuchte.

* Nicht kompatibel mit T5 Einsatzleuchten

HeliaLux Spectrum

- Speziell entwickelte Vollspektrum-LED-Einsatzleuchte mit maximaler Leistung
- Weiße, blaue, grüne und rote SMD-LEDs für maximale Brillanz im Aquarium



HeliaLux SmartControl

WLAN-Steuerung für HeliaLux Einsatzleuchten

- Farben einzeln steuerbar
- Zur Steuerung der HeliaLux Spectrum
- Individuell programmierbare Tagesabläufe
- In Verbindung mit HeliaLux LED Splitter auch geeignet zur Steuerung der HeliaLux LED
- Wolkeneffekte individuell programmierbar
- Fünf vorkonfigurierte Profile vorinstalliert



HeliaLux SmartControl

UniversalFit

Universalhalterung für alle HeliaLux Einsatzleuchten passend für alle Aquarien



HeliaLux Spectrum Splitter



HeliaLux LED Splitter

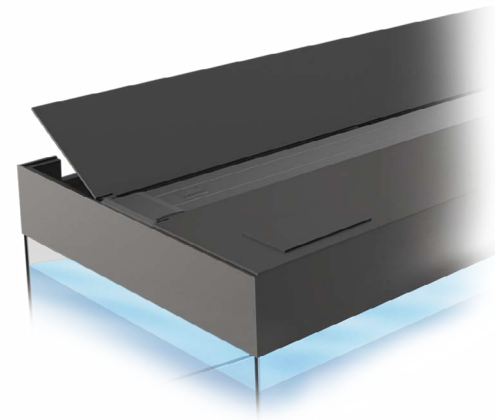
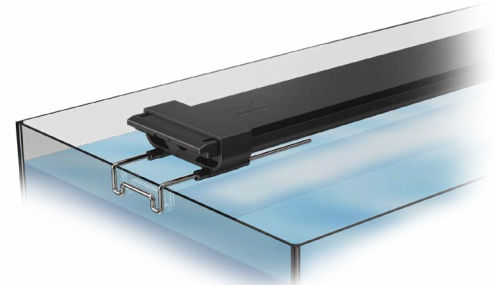

HeliaLux Splitter

Adapter für den Betrieb von bis zu zwei HeliaLux Einsatzleuchten am HeliaLux SmartControl





JUWEL DEKORATIONSKONZEPTE

Für mehr Tiefenwirkung im Aquarium

Cliff

- Das Dekorationskonzept Cliff Dark besticht durch seinen natürlichen bräunlichen Farbton.
- Cliff Light ist eine naturgetreue Nachbildung eines hellen, sandfarbenen Felsens.



CLIFF RÜCKWÄNDE

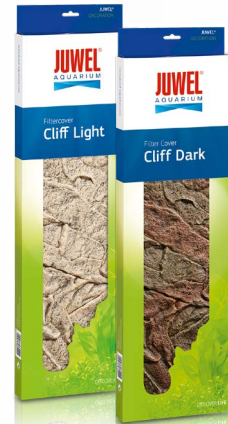

CLIFF FILTERVERKLEIDUNG

Stone

- Das Dekorationskonzept Stone ist eine naturgetreue Nachbildung einer lehm- und granitfarbenen Felswand.



STONE RÜCKWÄNDE

STONE FILTERVERKLEIDUNG



STR RÜCKWAND

STR

- Ausgeprägte Rindenstruktur

Conexo

DEKORATIONSKLEBER

- Zur dauerhaften Befestigung von Rückwänden



POSTER DEKORATION

POSTER Rückwände S, L, XL

- Für alle Aquarien von 60 bis 150 cm
- Zwei attraktive Motive auf jeder Rückwand



POSTER 1 Vorderseite

POSTER 3 Vorderseite

black

POSTER 3 Rückseite

white



POSTER 4 Vorderseite



POSTER 1 Rückseite

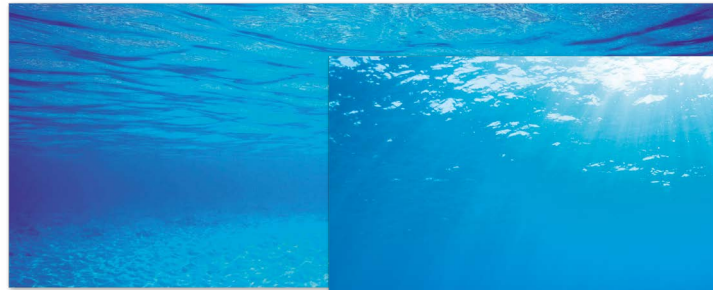

POSTER 2 Vorderseite

POSTER 2 Rückseite

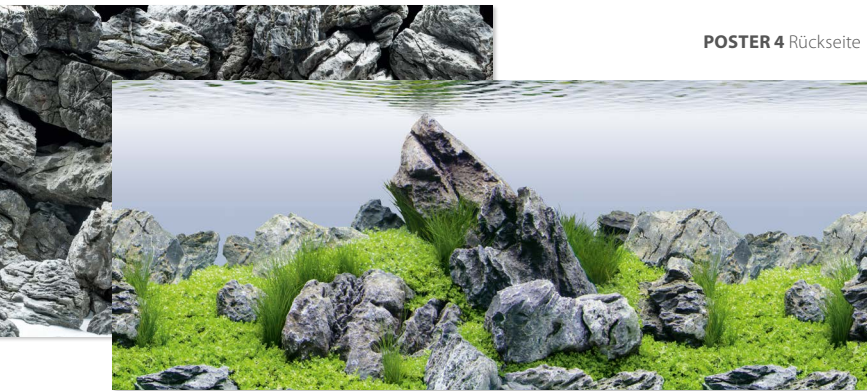

POSTER 4 Rückseite



POSTER Fix

JUWEL PosterFix ist ein Öl zur Verstärkung der plastischen Wirkung Ihrer Folienrückwände.

- Einfache Handhabung
- Minimiert Reflexionen
- Problemlos wieder ablösbar
- Verstärkt die Farbintensität

SmartCam

Unterwasserkamera

Die JUWEL SmartCam ermöglicht das komfortable Überwachen Ihres Aquariums von jedem Ort.



PanoramicView

mit 120° Kamerawinkel alles im Blick haben



EasySnap

Integrierte Foto- und Videofunktion



SimpleShare

Kamerafreigaben zum Teilen über die JUWEL App



GlobalAccess

Weltweiter Zugriff auf die Kamera über die JUWEL App

PERFECT
FIT



Digital Thermometer 3.0

Digital Thermometer mit großem Display perfekt integriert

- Perfekt integriert in das JUWEL Design
- Süß- und Meerwasser geeignet
- Präzise: +/- 0,5°C
- Passend auch für Aquarien anderer Hersteller dank beigefügtem Saugnapf

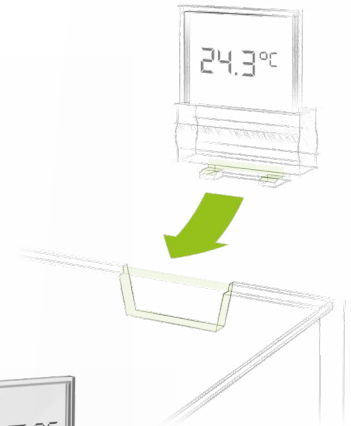
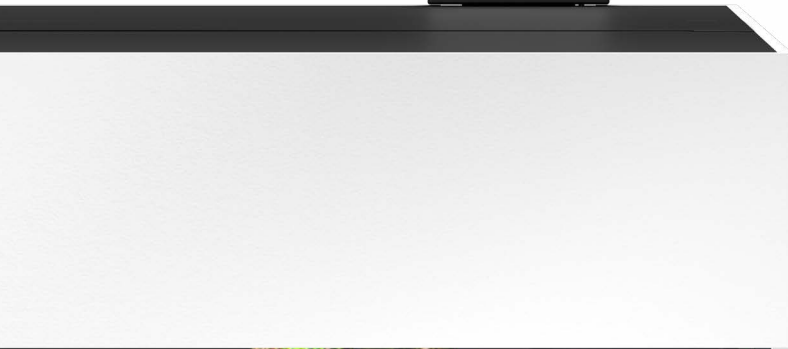



EccoSkim

Oberflächenabsauger

- Fördert Oberflächenrückstände direkt in den JUWEL Filter
- Entfernt Kahlhaut und organische Rückstände
- Fördert den Sauerstoffgehalt
- Für alle Aquarien geeignet dank beiliegender Saughalterung



FilterGrid

Feinmaschiger Einlaufschutz

- Reduziert das Eindringen von kleinsten Garnelen und Fischen in den JUWEL Bioflow Filter
- Reduziert die Größe der oberen und seitlichen Einlaufschlitze
- Keine Verringerung der Durchflussmenge
- Passend für Bioflow Filter Super, M, L und XL

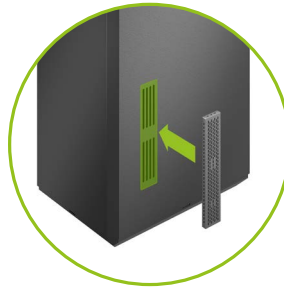
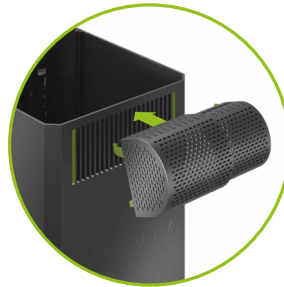

AquaClean 2.0

- Ideal zur Reinigung des JUWEL Filters sowie des Bodengrundes
- Inklusive Adapter zur Reinigung des JUWEL Innenfilters
- Einfaches, wiederholtes Zusammendrücken der Pumpe aktiviert sofort den Wasserfluss



EasyFeed

Der passende Futterautomat für das JUWEL Aquarium

- Regelbare Dosierung
- Bis zu zwei Fütterungen am Tag programmierbar



SmartFeed 2.0

Der komfortable Futterautomat für jedes JUWEL Aquarium

- Bis zu 3 Fütterungen am Tag
- Drei Fütterungs-Intervalle einstellbar (24/48/72h)
- Futtermenge in 8 Stufen dosierbar
- Austauschbare Förderschnecken für Granulat- und Flockenfutter
- Inklusive Futterkammer-Erweiterung
- USB-Anschluss für Dauerstromversorgung



EasyInstall

Step > by > Step



EINRICHTUNGSBEISPIELE













Lassen Sie sich von unseren Einrichtungsbeispielen inspirieren und erschaffen Sie wunderbare Unterwasserwelten ganz einfach mit Hilfe unserer Schritt für Schritt Anleitungen.



















www.juwel-aquarium.com/step-by-step



TECHNISCHE DATEN

	PRIMO 70 LED	PRIMO 110 LED	LIDO 120 LED	LIDO 200 LED	RIO 125 LED	RIO 180 LED
						
Filtertyp	Bioflow ONE	Bioflow Super	Bioflow M	Bioflow M	Bioflow M	Bioflow M
Filtervolumen	0,5 l	1,5 l	3,5 l	3,5 l	3,5 l	3,5 l
Pumpe	Eccoflow 300	Eccoflow 500	Eccoflow 500	Eccoflow 600	Eccoflow 500	Eccoflow 600
Pumpenleistung	300 l/h	500 l/h	500 l/h	600 l/h	500 l/h	600 l/h
Wattage Pumpe	4,4 W	5,5 W	5,5 W	7 W	5,5 W	7 W
Beleuchtung	NovoLux LED 60 1 x 8 W	NovoLux LED 80 1 x 10,5 W	MultiLux LED 2 x LED Tube 438 mm	MultiLux LED 2 x LED Tube 590 mm	MultiLux LED 2 x LED Tube 590 mm	MultiLux LED 2 x LED Tube 895 mm
Heizer	50 W	100 W	100 W	200 W	100 W	200 W
Dekore	 bl w	 bl	 bl g w lw	 bl g w lw	 bl g w lw dw	 bl g w lw dw

RIO 240 LED	RIO 350 LED	RIO 450 LED	VISION 180 LED	VISION 260 LED	VISION 450 LED	TRIGON 190 LED	TRIGON 350 LED
							
Bioflow M	Bioflow L	Bioflow XL	Bioflow M	Bioflow L	Bioflow XL	Bioflow M	Bioflow XL
3,5 l	8 l	11 l	3,5 l	8 l	11 l	3,5 l	11 l
Eccoflow 600	Eccoflow 1000	Eccoflow 1000	Eccoflow 600	Eccoflow 1000	Eccoflow 1000	Eccoflow 600	Eccoflow 1000
600 l/h	1000 l/h	1000 l/h	600 l/h	1000 l/h	1000 l/h	600 l/h	1000 l/h
7 W	8 W	8 W	7 W	8 W	8 W	7 W	8 W
MultiLux LED 2 x LED Tube 1047 mm	MultiLux LED 2 x LED Tube 1047 mm	MultiLux LED 2 x LED Tube 1200 mm	MultiLux LED 2 x LED Tube 742 mm	MultiLux LED 2 x LED Tube 1047 mm	MultiLux LED 2 x LED Tube 1200 mm	MultiLux LED 2 x LED Tube 590 mm	MultiLux LED 2x LED Tube 438 mm 2x LED Tube 895 mm
200 W	300 W	300 W	200 W	300 W	300 W	200 W	300 W
 bl g w lw dw	 bl w lw dw	 bl w lw dw	 bl w lw	 bl w lw	 bl w lw	 bl w lw	 bl w lw



Weitere Informationen zu JUWEL Aquarium Produkten sowie
JUWEL Aquarium Händlern in Ihrer Nähe finden Sie unter:

www.juwel-aquarium.com

JUWEL Aquarium AG & Co. KG

Karl-Göx-Straße 1
D-27356 Rotenburg/Wümme
GERMANY

Service-Hotline +49 (0) 42 61/93 79-32

Service-Fax +49 (0) 42 61/93 79-856

Service-Mail service@juwel-aquarium.de

© JUWEL, Trigon, Vision, Primo, Rio, Lido, PrimoLux, MultiLux, HeliaLux, NovoLux, HiLite, Twin-Lite, Warm-Lite, Colour-Lite, Day-Lite, Bioflow, FilterGrid, Eccoflow, SeaSkim, JUWEL Aqua Clean, bioPad, bioCarb, Cirax, Nitrox, Phorax, Carbox, Amorax, HiFlex, UniversalFit, NovoLux DayControl, HeliaLux SmartControl, EccoSkim, SmartFeed, EasyFeed

© JUWEL® Aquarium

© Apple, das Apple-Logo und iPhone sind Marken der Apple Inc., die in den USA und weiteren Ländern eingetragen sind.

Design by **R** — **J**
www.redeleitundjunker.de

ÜBERREICHT DURCH:

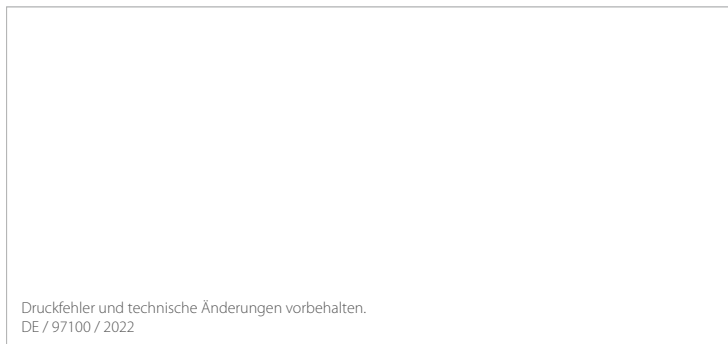

Druckfehler und technische Änderungen vorbehalten.
DE / 97100 / 2022