



MONTAGEANLEITUNG

SB 835

Assembly instructions
Instructions de montage
Montage handleiding
Istruzioni per il montaggio
Instrukcja montażu
Инструкция по монтажу
安裝說明

JUWEL AQUARIUM GmbH & Co. KG

Karl-Göx-Straße 1
D-27356 Rotenburg/Wümme
Telefon +49 (0) 42 61 93 79-0
Telefax +49 (0) 42 61 93 79-856
Service-Hotline +49 (0) 800 027 8274
Service-Fax +49 (0) 800 127 8274
Service-Mail service@juwel-aquarium.de

JUWEL AQUARIUM UK Branch

Gateway 11 Business Park
Pentfold Drive, Wymondham · Norfolk NR18 0WZ
Telefon 01953 606 363
Telefax 01953 603 839
Service-Mail info@juwel-aquarium.co.uk

Technische Änderungen vorbehalten.
We reserve the right to make technical alterations.
Sous réserve de changements technique ultérieurs.
© JUWEL AQUARIUM

100 769/1114

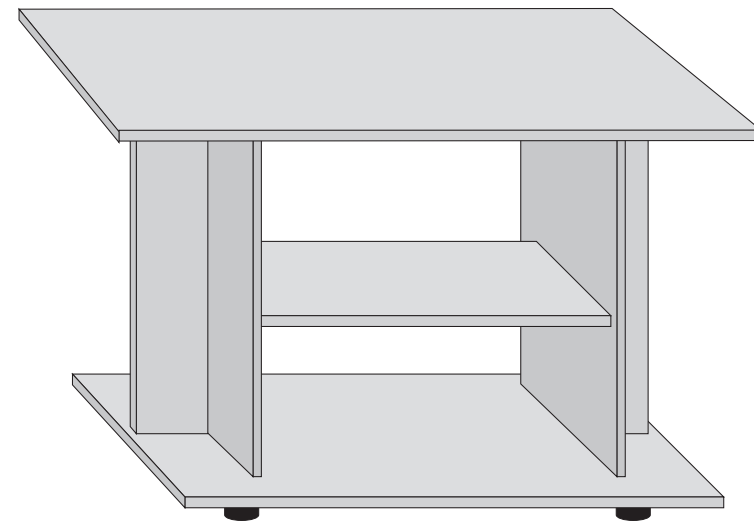

www.juwel-aquarium.com

SB 835

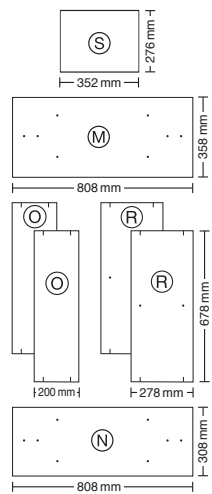

Für Aquarien	80 x 35 cm	M = 80,8 x 35,8 cm
For aquariums	80 x 35 cm	N = 80,8 x 30,8 cm
Pour aquariums	80 x 35 cm	
Für Aquarien	80 x 30 cm	M = 80,8 x 30,8 cm
For aquariums	80 x 30 cm	N = 80,8 x 35,8 cm
Pour aquariums	80 x 30 cm	

